



Standard  
Club

By your side

A Master's Guide to:

# Fire safety on ferries

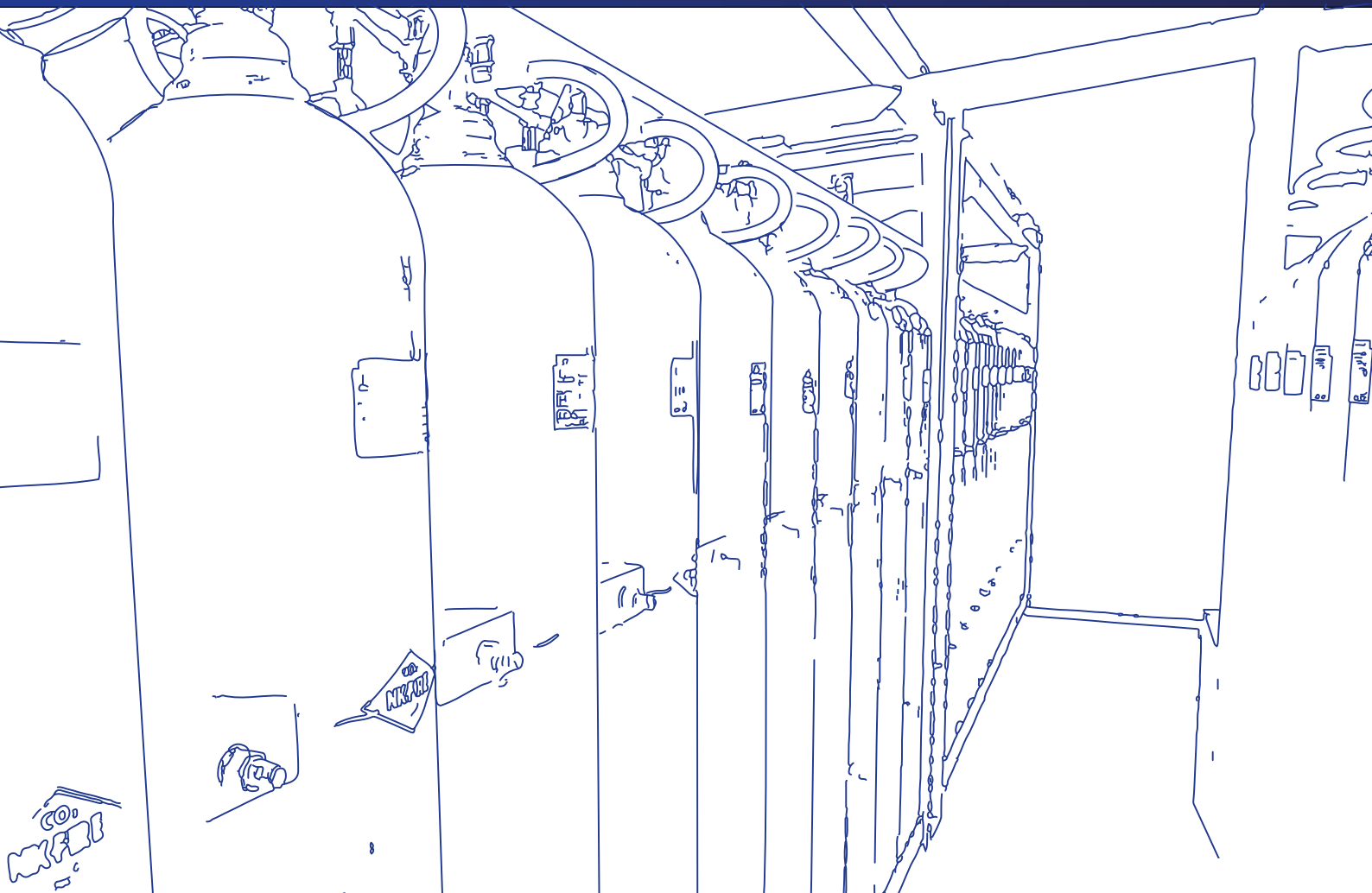

---

# About this Guide

The purpose of this guide is to promote best practice in fire safety, and to raise awareness of fire risks in general and fire risk on ferries in particular.

As part of the Loss Prevention department's continuing commitment to safety at sea, a number of 'Master's Guides' have been produced. They focus on delivering best practice advice on key areas of vessel operations to avert avoidable claims and prevent accidents, casualties and incidents at sea. These guides were created by harnessing the professional knowledge of members in the Loss Prevention team who have served at sea.

The guide to Fire Safety on Ferries is written for mariners, although surveyors, safety professionals and anyone with an interest in marine safety will find it of use. We have assumed that mariners have completed basic firefighting training and so we have not attempted to teach this or write a firefighting manual. We have also assumed that mariners have experience of the fire prevention, detection and extinguishing systems on ferries, and therefore we have not delved too deeply into design but have attempted to explain the basics, their strengths and weaknesses, what can go wrong and what mariners can do to improve fire safety.

**Captain Yves Vandeborn, Director of Loss Prevention**

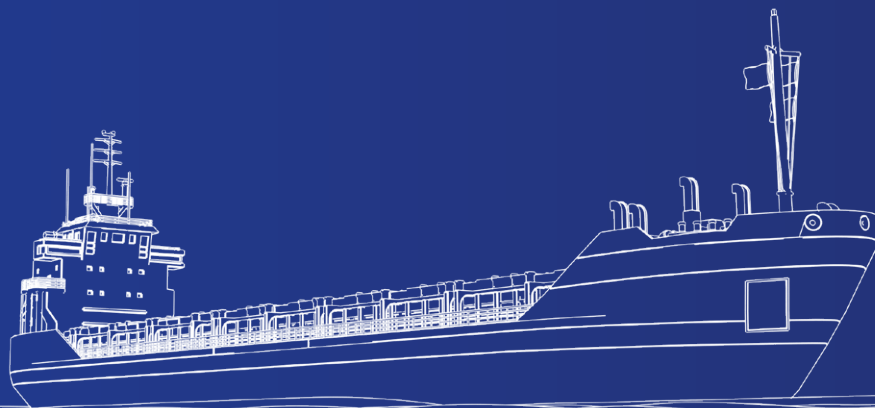

# Contents

<b>01. Introduction</b>	<b>4</b>	<b>06. Emergency preparedness</b>	<b>25</b>
<b>02. Basic advice</b>	<b>5</b>	<b>07. The human element</b>	<b>28</b>
Safe garage spaces	5	<b>08. Accident investigation</b>	<b>29</b>
Causes of fire	5	<b>09. Dos and don'ts checklist</b>	<b>31</b>
Fire characteristics	6	<b>10. Appendix 1: Case studies</b>	<b>33</b>
Basic firefighting	7	Fire on board <i>Commodore Clipper</i>	33
<b>03. Basic fire science</b>	<b>8</b>	Fire on board Corona Seaway, Kattegat	34
Fuels	8	Fire on board Lisco Gloria, north-west Fehmarn	35
Properties of exemplar fuels	9	<b>11. Appendix 2: SOLAS chapter II-2, fire safety requirements on ship construction – fire protection, detection and extinction</b>	<b>36</b>
Ignition of combustible material	10	<b>12. Appendix 3: IMO Circulars</b>	<b>37</b>
Exemplar fuels and fire	11	<b>List of figures</b>	<b>38</b>
Fire spread	12	<b>Authors</b>	<b>39</b>
<b>04. Fire safety and ferry construction</b>	<b>13</b>		
Fire protection	14		
Fire detection	15		
Fire extinguishment	15		
<b>05. Firefighting equipment and its use</b>	<b>16</b>		
Fixed firefighting equipment	16		
Fire main	17		
Water sprinkler	17		
Water deluge	19		
High-pressure water spray (mist or fog)	20		
High-expansion foam	22		
Carbon dioxide	23		
Safety when using CO <sub>2</sub> systems	24		
Portable firefighting equipment	24		

---

# 01. Introduction

A fire is one of the most frightening things that can happen at sea. Often, seafarers have no ready access to the emergency services when a fire breaks out and will need to rely on their own resources, courage and training to tackle and extinguish the blaze quickly to ensure the safety of the ship and everyone on board.

Ferries have particular risks from the cargo they carry – cars, lorries and refrigerated containers all contain combustible material and have their own fire hazards which a ship’s crew cannot easily control. Even though great attention is paid to fire safety during ferry design and construction, fires can and do occur and when they do, they can spread very quickly. It is therefore vitally important that ships’ crews react quickly to the early signs of any fire and use all available equipment and methodologies in the most efficient and effective way. To do this, ships’ crews need to have a thorough understanding of the use and limitations of the fire detection/ extinguishing equipment available to them as well as a good knowledge of how these should be used.

Fire safety is one of the first topics discussed during pre-sea induction training, when basics such as raising the alarm, closing fire doors and using portable fire extinguishers are taught. Later, crew attend firefighting courses and, when on board, regular fire drills are held. Accidents investigated by the Marine Accident Investigation Branch (MAIB) and other investigation bodies have shown that, even after significant training and drills, ships’ crews are not always experienced firefighters and mistakes made with basic fire awareness/safety have caused or contributed to their failure to successfully contain or extinguish a fire.

This guide has been written to raise awareness of the likely fire risks on ferries, to improve crew knowledge of fire safety and to discuss lessons learnt from accident investigation. The guide is not a firefighting training manual but it is a practical guide on basic fire science, the causes and prevention of fires, best practice in fire safety, and the strengths and weaknesses of fire safety in ferry design and firefighting equipment. Most importantly, it covers what a ship’s crew can do to prevent ship loss through fire.

The guide is recommended to all who have an interest in fire prevention on board ship.

## 02. Basic advice

The heat and products of combustion liberated by fire are harmful to life and are capable of causing severe damage to a ship. The areas on ferries that have greatest fire risk are the ones that contain materials that readily ignite and burn, or that have sufficient energy to result in serious fire. In many cases, these areas also contain viable source(s) of ignition, which means a fire could occur unless appropriate precautions are taken to prevent it.

The detection of heat, smoke and flames, either by a person or a fire detection system, are the primary means for fire detection. With the increasing use of hybrid and electric vehicles, operators should carefully plan their activities with respect to positioning the vehicles, and detecting and fighting fires in the storage area.

### Safe garage spaces

A safe garage space:

- is free from accumulations of combustible material
- has no unnecessary sources of ignition. This is achieved by implementing a strict no smoking policy, controlling hot work, maintaining safe electrical systems and restricting access by unauthorised personnel
- can be closed and sealed, using the doors and dampers provided, in the event of fire
- has closed fire doors and ramps, except when loading or discharging cargo
- has operational fixed fire detection and extinguishing systems, which are regularly examined and tested by crew who understand their use
- is thermally insulated using insulation with the correct fire retardant (eg A60), which is maintained in good condition so as to restrict the transfer of heat from one space to another.



Figure 1: Garage space on ship

### Causes of fire

There are numerous causes of fire, but the most relevant to ferries are:

- electrical defects, such as overloaded electrical equipment, damaged cables and poorly formed connections. Electrical faults in vehicles, especially when engines are hot/running. Reefer containers are major sources of fire
- mechanical failure, such as ignition from overheated bearings or a catastrophic engine failure
- uncontrolled release of oil or flammable liquid coming into contact with a hot surface, or the release of a low flashpoint fuel, such as petrol vapour, coming into contact with a source of ignition
- dry, readily combustible materials (such as wood, paper, textiles) coming into contact with an ignition source, such as a lighted cigarette, sparks or conducted heat from burning or cutting, high-intensity lights or defective electrical equipment.



Figure 2: Road trailer

A ship's crew can assess fire risk from the ship's systems and equipment, and take action, but they cannot easily assess fire risk from vehicles. Vehicles have the same or greater fire risk as the ship itself. They contain fuel, cellulosic material and plastics. Faults with their electrical systems, as case studies show, are a major source of ignition. During a fire patrol, pay special attention to vehicles with operating fans (after loading), those with a large volume of cellulosic material and any smelling of fuel. Report these to the safety officer.

#### Fire characteristics

- The burning of combustible material results in the liberation of heat in a self-sustaining reaction. The burning process continues until the fuel or the oxygen in the space has been consumed or until the fire is extinguished.
- Fire produces toxic smoke. The smoke is a cocktail of chemicals which are harmful to health.
- Exposure to smoke without the protection of a breathing apparatus should be avoided.
- Oxygen concentration in the atmosphere influences how a fire burns. When oxygen levels are reduced, the fire will be subdued, but it may continue to burn, albeit at a slower rate, and give off smoke and combustible vapour. Allowing more air into a space with a subdued fire can cause the fire to reignite/flare up. It may also result in the sudden and violent ignition of unburnt smoke and vapour within the space (flash-over).



- Fire spreads by convection, conduction and radiation:
  - Convection involves heat transfer through rising and circulating hot gas.
  - Conduction involves heat energy transfer through solid material, eg a steel bulkhead.
  - Radiation involves the emission of heat from a fire through air to material that is not in direct contact with the fire.

Compartment boundaries with fire-protecting insulation can prevent the spread of fire by conduction.

Unsealed pipe and cable penetrations in compartment boundaries compromise fire safety. They must be sealed with appropriate fire resisting material. It is important to ensure that fire-protecting insulation and fire stopping are complete and in good condition.

### Basic firefighting

- Fire is extinguished by removal of any of the three elements of the fire triangle – heat, oxygen or fuel:
  - Oxygen is removed when a space is closed and sealed, and the oxygen is consumed by the fire. Oxygen can also be displaced by the release of inert gas such as CO<sub>2</sub>. Foam can restrict oxygen reaching the fuel's surface.
  - Heat is removed by cooling with water, which also generates steam. Steam has a smothering effect by displacing oxygen.
  - Fuel, in the form of cargo, packaging and dunnage, is difficult to remove from most compartments. Good housekeeping and the removal of unnecessary combustible material is essential.
- Portable fire extinguishers are filled with different extinguishing materials such as water, foam, dry powder and CO<sub>2</sub>:
  - Water is used on dry material fires.
  - Foam is used on fires involving combustible liquids and solids.
  - Dry powder can be used on fires involving dry materials, liquid fuels, flammable gases, electrical equipment (excluding high-voltage equipment).

- CO<sub>2</sub> is ideal for electrical fires and liquid fuel fires. CO<sub>2</sub> is an asphyxiant. When using, care is needed.
- Fixed firefighting systems on board ferries typically use:
  - water in deluge, sprinkler and mist systems
  - CO<sub>2</sub> in enclosed garage and machinery spaces
  - foam in garage spaces.
- When fighting a fire, it is essential to:
  - wear a fireman's outfit, if near flame or heat
  - wear a breathing apparatus, if entering a space in which a large fire is burning or has burnt
  - work as part of a firefighting team, except on those very small fires easily extinguished with a portable extinguisher.

Never enter an enclosed space where there has been a fire without wearing a fireman's outfit or a breathing apparatus, unless the space has cooled and the oxygen content has been verified as safe to enter.



Figure 3: Firemans suits

## 03. Basic fire science

The fire triangle can be used to explain the conditions necessary for fire to occur.

It illustrates the principle that if an oxidiser (normally oxygen in air), a source of fuel and a source of ignition (heat) come together, then a fire can occur, ie there will be a self-sustaining exothermic (liberating heat) chemical reaction.

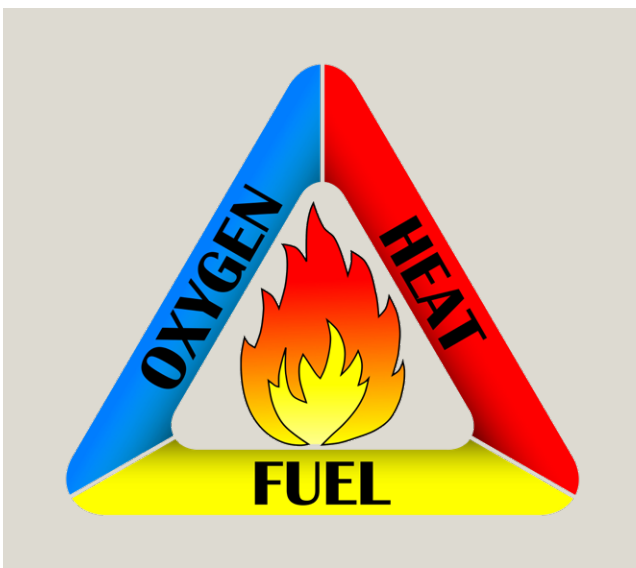

Figure 4: Fire triangle

In simple terms, firefighting involves breaking the fire triangle by eliminating one or more of its elements. Typically, this involves removing either the heat (by cooling with water) or the oxidiser (by excluding air with a non-combustible gas such as CO<sub>2</sub> or smothering the fuel with foam). In practice, removing fuel that is inherent to a cargo space is very difficult.

The fire triangle can be used when conducting fire risk assessments and implementing measures to prevent the three elements from coming together and causing a fire. High-risk areas such as garage spaces, galleys and machinery spaces have a plentiful supply of oxygen in air. To avoid fire, it is necessary to control the presence of fuel and the sources of ignition.

### Fuels

The following fuels are found on ferries:

- **Cellulosic material**, including cardboard, paper, cotton waste, cotton rags and sawdust
- **Solid timber**, including dunnage, pallets, crates, timber structures and cladding material
- **Liquid fuels below their flashpoint**, including gasoil, diesel oil, lubricating oil, hydraulic oil and cooking oil
- **Liquid fuels above their flashpoint**, including gasoline (petrol), some paint thinners, solvents and preheated fuel oil
- **Thermosetting plastics**, including plastics used in vehicle construction, electrical fittings and thermal/acoustic insulation such as rigid polyurethane foam
- **Thermoplastics**, including a range of plastics used in vehicle construction, and PVC and polystyrene foam found in packaging
- **Gases**, including LPG (vehicle fuel, portable cooking/heating appliance cylinders) and gases for welding/cutting, such as propane and acetylene.

These fuels are present both on the ship and on vehicles loaded on board.

When discussing fuel and fire risk, reference is made to the following:

- **Flashpoint** – this is the lowest temperature at which the concentration of the vapour in air above a liquid's surface becomes flammable and is capable of being ignited by an external ignition source, such as a naked flame or an electric spark.
- **Fire point** – the temperature at which the concentration of vapour in air, at the surface of a fuel, exceeds a minimum level at which it can be ignited by an external ignition source and burn freely. The fire point of a liquid is the temperature at which the rate of evaporation is sufficient to sustain this minimum concentration. The fire point of a solid is the surface temperature at which the solid breaks down to release vapour



at a concentration sufficient to support flame. The fire point of a liquid is slightly higher than the flashpoint.

- **Autoignition temperature** – the autoignition temperature of a substance is the lowest temperature at which it will spontaneously ignite, in air, without an external source of ignition. This is the parameter to consider when assessing the risk of liquid fuel being ignited on a hot surface.



Figure 5: Fuel source stored above flashpoint temperature

- **Flammability limits** – the flammability limits (sometimes called explosibility limits) are the upper and lower ranges of gas or vapour concentration in air, between which it can be ignited on contact with an ignition source. A mixture below the lower flammability limit is too lean to be ignited and a mixture above the upper flammability limit is too rich to be ignited.
- **Spontaneous ignition** – some bulk solids and solids contaminated with certain liquids/oils can react with oxygen or self-react to liberate heat after exposure to moderately elevated temperatures. This reaction causes the temperature of the material to increase by a process of self-heating which can eventually lead to ignition occurring spontaneously. In some bulk solids, the initial temperature increase could be due to biological action or heat from an adjacent heated surface.

### Properties of exemplar fuels

Fuel	Flashpoint (°C)	Autoignition temperature (°C)	Flammability limits		Susceptibility to spontaneous heating
			Lower (vol %)	Upper (vol %)	
Acetylene (gas)	-	305	2.5	100	-
Butane (gas)	-60	410-585	2	9	-
Acetone	-18	535	2.6	12.8	-
Corn oil	254	393	-	-	Moderate
Ethanol	13	365	3.3	19	-
Fuel oil	>60	254-407	0.45	-	-
Olive oil	225	343	-	-	Slight
Gasoline (petrol)	-43	250-400	1.3	6	-
Gas oil	66	338	6	13.5	-
Hydraulic oil	166-257	232-643	-	-	-
Kerosene	38-74	227	1.16	6	-
Linseed oil	222	343	-	-	Very high
Lubricating oil (SAE10/SAE60)	171/249	382/410	-	-	-
Paint thinners (Hempel 08450)	25	355	0.8	11.3	-

## Basic fire science continued

### Ignition of combustible material

Fire can result from a deliberate act; however, most fires are caused by accidental ignition and, in this guide, we focus on these.

Common sources of ignition on ferries are:

- carelessly discarded smoking material, such as lighted cigarettes and matches
- sparks from grinding, cutting, burning or welding
- heat directly transferred by conduction to combustible material on the reverse side of a deck or bulkhead – often associated with hot work
- malfunctioning or defective electrical equipment, including, but not limited to, vehicle electrics, reefer container electrics or lithium-ion batteries
- overloaded or overheating electrical circuits and/or connections
- high-intensity lights, such as halogen lights and switches
- hot engine exhausts
- mechanical failure, such as catastrophic engine failure, with ignition of escaping oil or ignition from overheating bearings
- portable heaters and cooking equipment
- galley equipment, such as deep fat fryers and cookers.

Not all of these ignition sources are viable with all fuels; for example, an electrical spark may ignite gaseous or liquid fuels above their flashpoint but is unlikely to ignite bulk solids or liquid fuels below their flashpoint. Likewise, sparks from some types of hot work are unlikely to ignite bulk solid material but could initiate a smoulder in relatively finely divided cellulosic material, such as cardboard, rags, wood shavings and cotton waste.

Consequently, carelessly discarded smokers' materials and hot work can ignite a smoulder while being unlikely to ignite directly a bulk solid or liquid fuel below its flashpoint. But significantly, once a smoulder has been ignited, it may subsequently develop into flaming fire. From this, it can be seen that ignition sources and the physical characteristics of materials should be considered together. The exemplar fuels and fire table describes the conditions required for ignition and typical sources of ignition for exemplar fuels.



Figure 6: Potential fuel source

## Exemplar fuels and fire

Fuel	Conditions required for ignition	Typical sources of ignition
<b>Cellulosic material</b> – cardboard, waste paper, cotton waste, cotton rags, sawdust.	Contact with a flame or hot surface for a sufficient length of time or exposure to radiated heat of sufficient intensity to reach its fire point, or exposure to a small hot surface for a sufficient length of time to initiate smouldering combustion.	Naked flames; hot work including welding, flame cutting and grinding; hot surfaces, such as engine exhausts; discarded smokers' materials; exposure to radiant heat from a halogen lamp or direct contact with a light bulb; and close contact with overheating electrical equipment.
<b>Solid timber</b>	Contact with a flame or hot surface for a sufficient length of time or exposure to radiated heat of sufficient intensity to reach its fire point.	Naked flames; hot surfaces, such as exhausts; sparks produced by hot work, such as welding, flame cutting; close contact with overheating electrical equipment; exposure to radiant heat from a halogen lamp or direct contact with a light bulb.
<b>Thermosetting plastics</b> – plastics used in vehicle construction, electrical fittings and rigid polyurethane foam insulation.	Contact with a flame or hot surface for a sufficient length of time or exposure to radiated heat of sufficient intensity to reach its fire point.	Naked flames; hot surfaces, such as exhausts; close contact with localised overheating electrical equipment; exposure to radiant heat from a halogen lamp.
<b>Thermoplastic materials</b> – plastics used in vehicle construction, PVC packaging and polystyrene foam.	Contact with a flame or hot surface for a sufficient length of time or exposure to radiated heat of sufficient intensity to reach its fire point.	Naked flames; hot surfaces, such as exhausts; close contact with localised overheating electrical equipment; exposure to radiant heat from a halogen lamp.
<b>Oils and liquids</b> stored and used at temperatures below their flashpoint, such as gas oil, diesel oil, lubricating oil and hydraulic oil.	<ol style="list-style-type: none"> <li>Contact with a source of heat that raises the liquid temperature above its flashpoint, so that the vapour evolved from the liquid becomes ignitable by an external ignition source.</li> <li>Contact with a source of heat that evaporates the liquid and which is at a temperature that exceeds the autoignition temperature of the vapour, causing the vapour to ignite spontaneously, without an external ignition source.</li> </ol>	<ol style="list-style-type: none"> <li>Naked flames; electrical sparks and arcs; sparks and other hot particles from hot work.</li> <li>Exposed engine exhausts, turbochargers, boiler combustion chambers and thermal fluid pipes at a temperature exceeding the autoignition temperature of the vapour.</li> </ol>
<b>Liquids</b> stored and used at temperatures above their flashpoint, eg gasoline (petrol), paint thinners, solvents and preheated fuel oils.	<ol style="list-style-type: none"> <li>Exposure of fuel vapour to a spark or naked flame.</li> <li>Contact with a surface at a temperature that exceeds the autoignition temperature of the vapour, causing the vapour to ignite spontaneously, without an external ignition source.</li> </ol>	<ol style="list-style-type: none"> <li>Naked flames; electrical sparks and arcs; sparks and other hot particles from hot work.</li> <li>Exposed engine exhausts, turbochargers, boiler combustion chambers and thermal fluid pipes at a temperature exceeding the autoignition temperature of the vapour.</li> </ol>
<b>Gases</b> , such as LPG and acetylene.	<ol style="list-style-type: none"> <li>Exposure of the gas to an electrical spark or naked flame.</li> <li>Contact with a surface at a temperature that exceeds the autoignition temperature of the gas, causing the gas to ignite spontaneously.</li> </ol>	<ol style="list-style-type: none"> <li>Electrical sparks and arcs; sparks and other hot particles from hot work.</li> <li>Exposed parts of engine exhausts, turbochargers at a temperature exceeding the autoignition temperature of the gas.</li> </ol>

## Basic fire science continued

### Fire spread

Fire spreads within a compartment and through openings by the motion of hot gas (convection) and the emission of heat energy (radiation). A ship's metal structure readily allows fire spread from the compartment containing the fire to an adjacent compartment by direct transfer of heat through the material (conduction). Doors left open, and missing or damaged insulation are the main reasons why a fire will spread from its place of origin. Care should be taken to ensure fire doors are closed and structural fire protection is maintained in good condition throughout the life of the ferry.

The Safety of Life at Sea Convention (SOLAS) requires that ferries are constructed with structural boundaries to prevent the spread of fire from one compartment to another. This is achieved by means of sealing openings, controlling and isolating ventilation, and fitting thermal insulation on steel decks and bulkheads.

Fire safety and ferry construction is discussed in more detail in the next section.

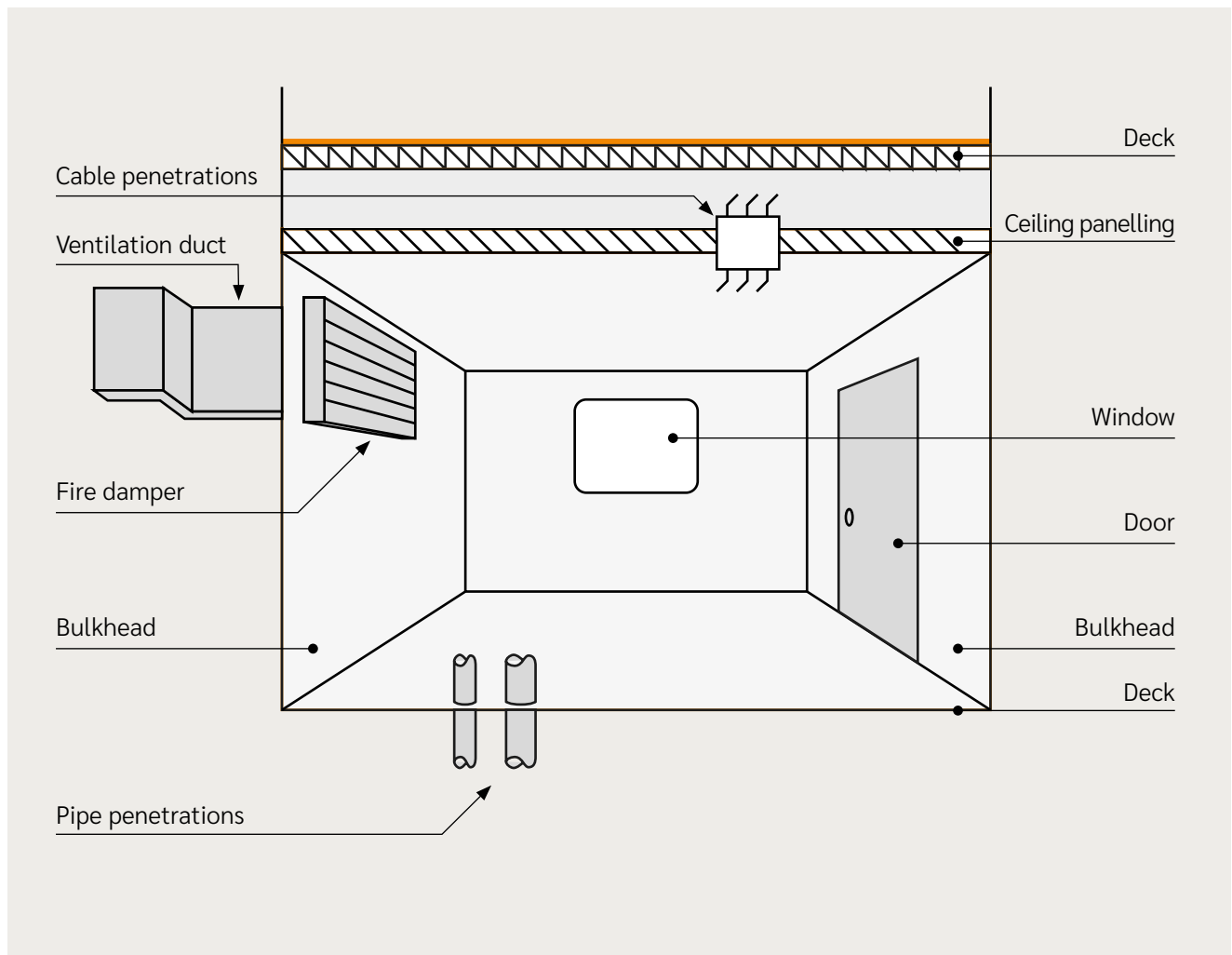

Figure 7: Compartment fire protection components



## 04. Fire safety and ferry construction

Ferries are constructed to contain and extinguish fire in accordance with eight principles of fire safety:

1. Division of the ship into vertical and horizontal zones by thermal and structural boundaries
2. Separation of the accommodation from the remainder of the ship by thermal and structural boundaries
3. Restricted use of combustible material
4. Automatic fire detection
5. Fire containment and extinction, in the space of origin
6. Protecting means of escape and firefighting access
7. Availability of fire-extinguishing appliances
8. Minimising ignition sources.

All ferries engaged on international voyages must comply with SOLAS. Chapter II-2 of the convention specifies the requirements for fire protection, detection and extinguishing (see Appendix 2).

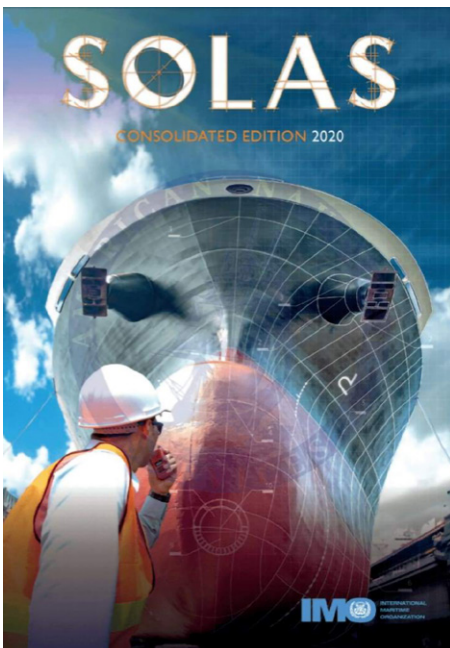

Figure 8: International Convention for the Safety of Life at Sea (SOLAS)

Ro-ro ferries are designed with specific features to facilitate their operational requirements, and in particular, to:

- maximise stowage space and allow vehicles to enter and leave the ferry – there are large, open garage space(s)
- remove vehicle exhaust gas – there are large, forced draft ventilators
- allow passengers to access passenger accommodation – there are stairways to and from the garage space(s)
- allow access to the machinery space – there are doors from the garage space(s).

These basic design requirements present a challenge to fire safety, making it more difficult to contain a fire in its place of origin through thermal boundaries, controlling air entering the space and removing flammable material. For these reasons, openings in the main vertical thermal boundaries, galley boundaries and stairway enclosures are provided with self-closing fire doors. Ventilation fans have emergency stops, and ventilation supply and exhaust ducts have dampers (flaps), which can be operated from outside the space.

Check the arrangements on your ferry and make sure all crew on board understand how to operate emergency stops and to remotely close fire doors and dampers (flaps). During a safety meeting, discuss the dangers of garage space fire and the means by which fire can spread from one compartment to another.



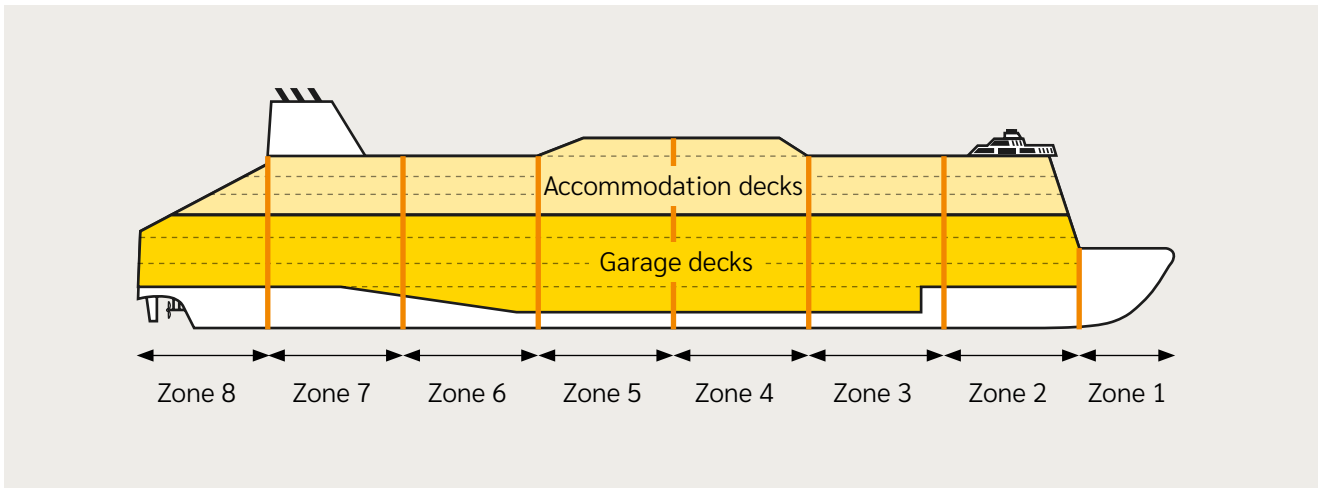

Figure 9: Ferry boundaries

### Fire protection

- A basic principle of fire protection is to contain a fire in the space of origin. A ship's hull, superstructure and deck houses are divided into vertical fire zones bounded by fire-retarding divisions (bulkheads and decks). These vertical fire zones are often in line with watertight/subdivision bulkheads. Their length and width do not normally exceed 48 metres and a maximum surface area of 1,600m<sup>2</sup>. However, a garage space on a ro-ro ferry is likely to exceed this size.
- Self-closing fire doors fitted throughout the passenger accommodation are placed in the boundary of a vertical fire zone for access to compartments in adjacent fire zones. This creates potential for fire to spread and is therefore a fire hazard. For this reason, each fire door should be shut and those self-closing doors that are kept open should be tested for closing every month.
- Uninsulated steel (minimum 4mm thick and stiffened) will stop the passage of smoke and flame for 60 minutes. The insulation on steel plate is to prevent the passage of heat.
- Uninsulated aluminium alloy will not stop the passage of smoke and flame. The insulation on aluminium will lengthen the time before it melts.
- A-class divisions are bulkheads, decks or doors, normally constructed from steel and insulated to prevent the passage of smoke, and flame for a period of not less than 60 minutes. A-class divisions can be insulated A-60, A-30, A-15 or A-0. The standard applied is that the temperature on the unexposed side should not increase by more than 140°C or by more than 180°C at joints, by the end of a standard fire test. An A-60 division will meet this requirement for a 60-minute test, and an A-30 division for a 30-minute test.
- A-60 divisions are fitted to create a vertical fire zone and to protect control stations (where controls for fire detection and extinguishing equipment are kept), escapes and areas where flammable liquids are stored.
- B-class divisions, although constructed from non-combustible material, can have combustible veneers. They have a lower standard of heat transfer when compared to A-class divisions and can be B-15 or B-0. B-15 divisions are insulated to prevent the rise in temperature on their unexposed side by a maximum of 140°C or on a single spot by 225°C for up to 15 minutes. They are capable of preventing the passage of flame for the first half hour of a standard fire test.
- B-class divisions are mostly fitted in the accommodation; otherwise, A-class divisions are more commonly used.
- C-class divisions are non-combustible divisions.

The arrangements on your ship will be shown on the ship's Fire Control plan. It is important to know them. Check where A-class divisions, particularly A-60 divisions, the highest level of protection, are fitted and identify the spaces with B-class and C-class divisions.

During modification of an insulated bulkhead, deck or door, the material fitted should be to the same fire safety standard as the existing material, ie any modification of an A-60 division must be to A-60 standard. Penetrations in insulated bulkheads for pipes and cables need to be fire stopped (sealed) and maintained to an equivalent insulation standard as the bulkhead.

### Fire detection

Fires are detected by either fixed fire detection systems or by personnel:

- Ferries have an automatic fixed fire detection system and manually operated call points fitted in spaces with the potential for fire, such as the accommodation, control, machinery and service spaces. The fire detection system has an audible and visible alarm. These fire detection systems can be addressable which provides a capability of fire zone identification due to individually identifiable fire detectors.
  - Self-activating fire detectors are invariably smoke detectors, rather than heat or flame detectors. Smoke detectors are preferable because they are able to detect a smouldering or small fire with very little heat. Heat/flame detectors may be used in locations where smoke can be present without fire, such as in a galley. A smoke detector can give a false alarm, but as the case studies show, any sounding fire alarm should always be investigated. The activation of a heat detector will normally mean the fire is established. Detector heads should be clean and unobstructed.
  - Fires can be detected by personnel in the space before the fixed detection system activates. Therefore, a diligent and regular fire patrol could identify a smouldering fire before smoke detectors activate.
- Manually activated call points are installed throughout the ship so that an alert can quickly be sounded upon discovering a fire.
  - Ships have video surveillance equipment. These are useful for seeing smoke after an alarm has sounded, but they are not the same as a fire alarm. Colour images make smoke easier to see. Care is needed if using black and white images because smoke may appear as shadows.

### Fire extinguishment

- Portable fire extinguishers are usually located at space entrances and at intervals therein, often at midpoints.
- All ships have a water fire main, hydrants and water hoses.
- Ferries have sprinklers and/or water mist systems in the accommodation and stairways, a deluge or high expansion foam system in the garage space, and water mist and/or CO<sub>2</sub> fire-extinguishing system in the machinery space. Cargo ro-ro's have fixed CO<sub>2</sub> fire-extinguishing systems in enclosed garage space(s).

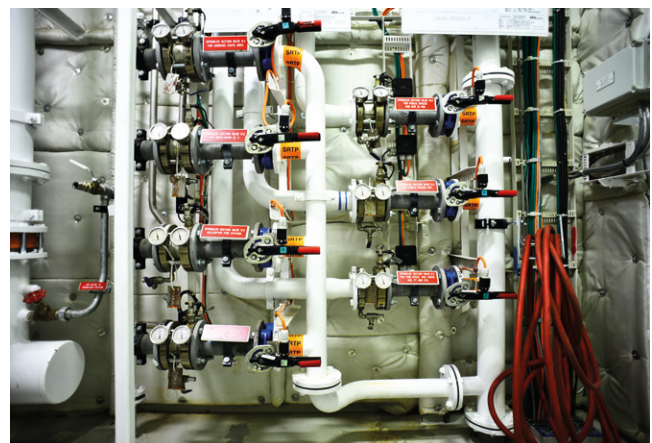

Figure 10: Water spray system valves for vehicle deck

## 05. Firefighting equipment and its use

A fire starting in the garage space will spread throughout the space, unless early action is taken to extinguish it.

Nascent fires can be extinguished using portable (hand-held) equipment of a type applicable to the material involved in the fire. Water hoses and/or foam branches may also be used on some small and developing fires. Large fires are extinguished using the fixed firefighting system.

Fixed fire-extinguishing systems have been proven to effectively extinguish fire, provided the correct

preparation is followed and they are released early. It is important to know how to operate the equipment on your ferry and the procedures to follow.

The effectiveness of fixed firefighting systems reduces as a fire intensifies. Therefore, it is essential to release the fixed system as quickly as possible and to only attempt manual firefighting on very small, accessible fires.

### Fixed firefighting equipment





	Type	Used	Tips
	<b>Sprinkler</b>	Cooling	Check piping is free from damage and that the compartment has the correctly rated nozzle. Never paint over nozzles. Check for cracked bulbs in readily accessible heads.
	<b>Drencher</b>	Cooling	Check manually operated valves are open and that nozzles are not blocked. Always verify if release controls are set to local or remote release.
	<b>High pressure water mist</b>	Smothering	Release water mist system as soon as a fire is confirmed. Never paint over nozzles. Check for cracked bulbs in readily accessible heads.
	<b>High expansion foam</b>	Smothering	Release foam as soon as a fire is confirmed.
	<b>CO<sub>2</sub></b>	Smothering	Before release, batten down and seal the compartment and verify that everyone on board the ship has been accounted for. CO <sub>2</sub> is a dangerous health hazard.

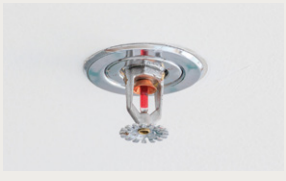
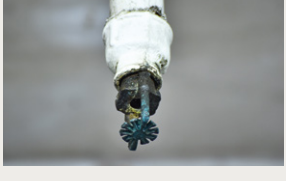

Figure 11: Hydrant

The principal fixed firefighting systems found on ferries are in accordance with SOLAS. These systems are described below.

### Fire main

Water-based firefighting system used with handheld hoses and a jet or spray nozzle, found throughout a ship:

- Water jets and/or spray with handheld fire hoses using seawater
- Minimum of two fire pumps connected to sea suction, plus an emergency fire pump located outside the main machinery space. Maximum capacity of a fire pump is 140m<sup>3</sup> per hour on a cargo ship, but is greater on some passenger ships
- Fire main constructed from steel
- Designed so that two jets of water can reach any part of the ship
- Always have an isolating valve between deck and engine room systems to prevent water loss if part of the fire main is damaged or broken
- Passenger ships carrying more than 36 passengers will have one hose for every fire hydrant and they should be constantly fitted in internal spaces
- Fire hoses are not more than 20m long unless the ship's breadth is over 30m.

### Maintenance tips

- Ensure that the fire pumps are maintained in accordance with the manufacturer's instructions. They should be tested and operated successfully in all loading conditions.
- Inspect the fire main for leakage (when pressurised) and permanently repair any leakages found.
- Regularly check and grease sealing washers in fire hydrants and on hoses.
- Ensure hydrant valves move freely, by hand.
- Use different hydrants during wash down.

### Water sprinkler

A fixed fire-sensing and firefighting system found in control and service spaces, and passenger accommodation (including corridors and stairways). Features automatic release of water from heat-activated sprinkler heads. Fire is extinguished by cooling. Provides blanket coverage.

- Sprinkler heads contain a glass bulb which ruptures to release water. They have different activation temperatures (indicated by different coloured bulbs) to prevent accidental release in spaces where heat can be present without fire. Activation temperatures are: red 68°C, yellow 79°C, green 93°C and blue 141°C.
- Sprinkler heads are grouped into separate sections with each section not containing more than 200 sprinklers.
- Multiple heads enable blanket coverage. Heads are designed to release water in a cone-shaped spray and are spaced to enable spray overlap and formation of a water sheet.
- A pressure drop when the system is activated triggers a fire alarm indicating the location of the sprinkler zone.
- Uses fresh water from a pressurised tank but can operate with seawater when the tank is empty.
- Operates at a minimum pressure of 4.8 bar.

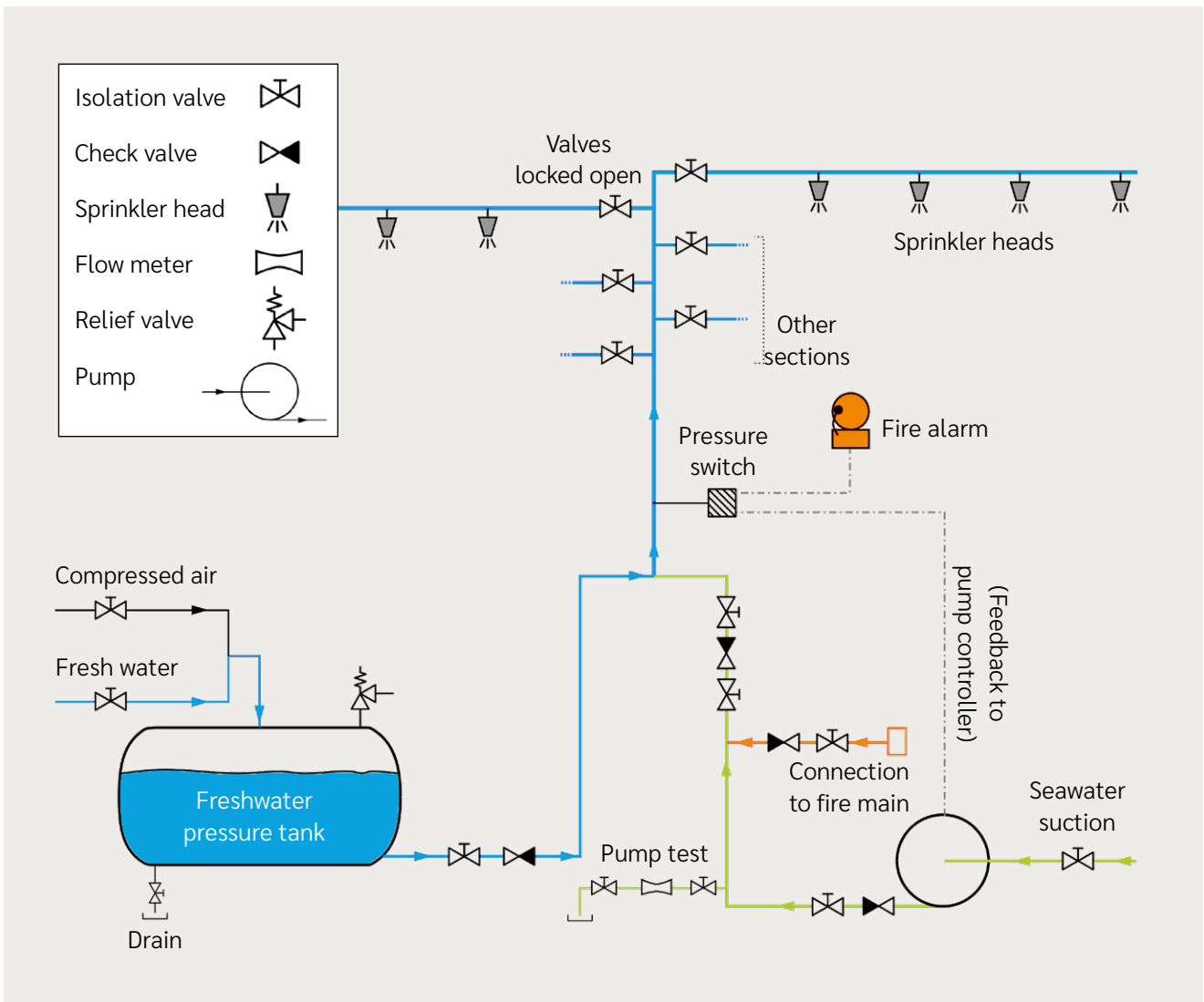

Figure 12: Water spray system

### Maintenance tips

- Follow manufacturer's maintenance instructions and statutory requirements set out in IMO MSC Circs 1432 and 1516 (see Appendix 3).
- Ensure operating instructions are clear and prominently displayed.
- Ensure that valves and other system components are correctly labelled and the position of each valve is correctly set. This is essential. Check that controls are in the automatic position and that the systems will deploy automatically. This is essential.
- Drain and clean pipework after testing with seawater.
- Never paint sprinkler nozzles, and regularly open and close manually operated valves, returning them to the correct position afterwards.



## Water deluge

A fixed fire-extinguishing system found in garage spaces. Method of extinguishment is by cooling, after manual release of water from fixed nozzles. Provides blanket coverage but may be a suppressant only if fire is shielded by closed-top, high-sided vehicles.

- Seawater sprayed from fixed discharge nozzles.
- Connected to large-capacity seawater pumps to enable release of large quantities of water.
- Manually activated from outside the protected space.
- Nozzle is open ended.
- Arranged similar to a sprinkler system except nozzles are closer together, ie 3.5m apart, in zones of at least 20m in length.
- Designed to simultaneously protect two adjacent fire zones with a minimum water release of 5l/m<sup>2</sup> to 15l/m<sup>2</sup>.
- Manually operated maintenance valves should be open, while remotely operated isolating valves should be kept shut.
- Releases large quantities of water, which can be a stability hazard if not drained away. Freeing ports should be kept clear.

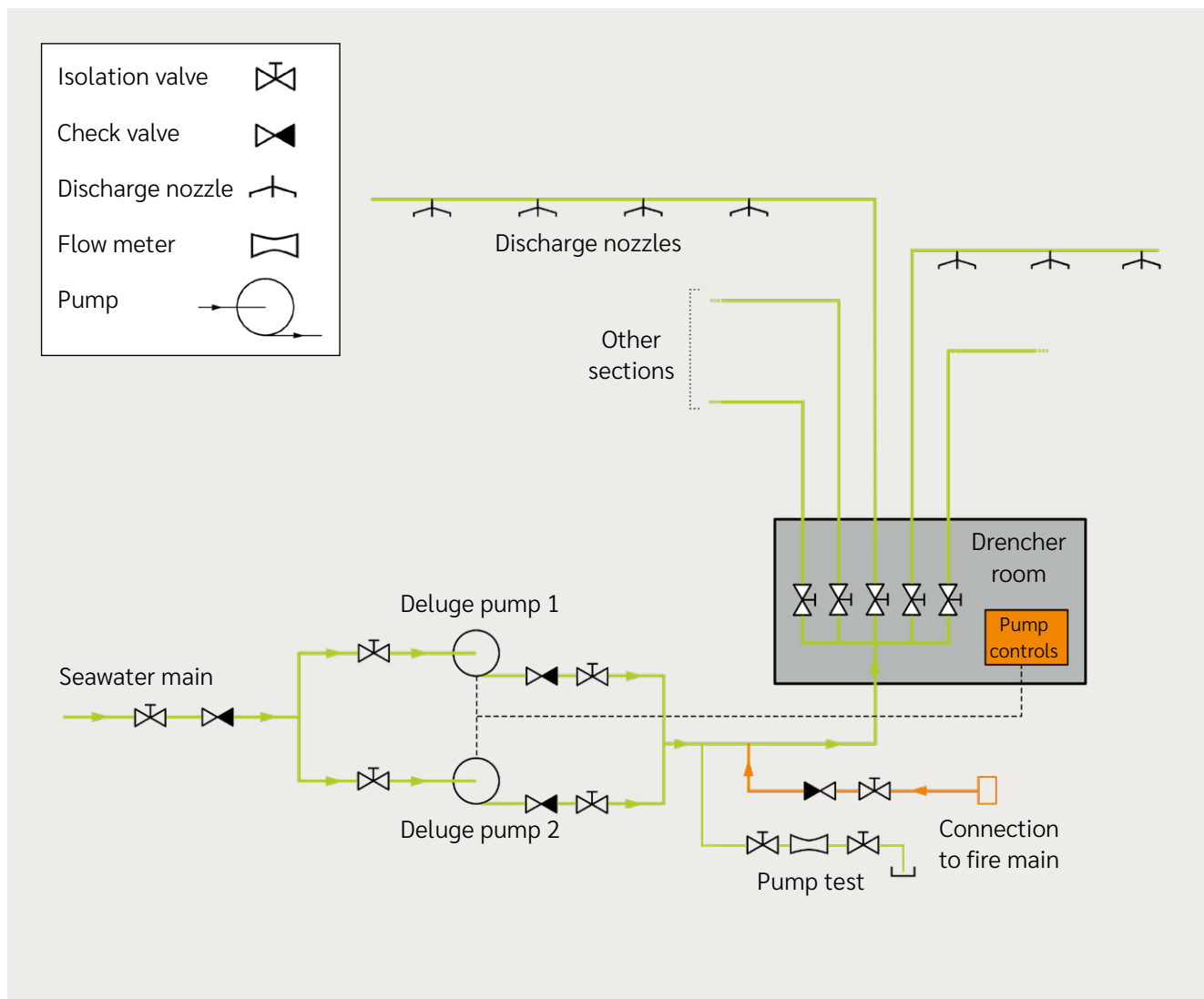

Figure 13: Vehicle deck drencher system

### Maintenance tips

- Follow manufacturer's maintenance/operating instructions and statutory requirements set out in IMO MSC Circs 1432 and 1516 (see Appendix 3).
- Ensure operating instructions are clear and prominently displayed.
- Ensure that valves and other system components are correctly labelled. This is essential.
- Check that controls are set for remote rather than local release.
- Use a different section of the deluge system each week for washing down ro-ro decks and thereby complete systematic operational tests.

### High-pressure water spray (mist or fog)

A fixed fire-extinguishing system is commonly found throughout the vessel and in machinery spaces, it may be used in conjunction with fixed CO<sub>2</sub>.

The method of extinguishment is by cooling and smothering through the production of steam. Water release is automatic or manual, at high pressure, from fixed nozzles in a water fog or mist. It provides volume coverage, but is commonly used for automatic protection of accommodation areas and for Local Application Systems protecting high-risk areas in the machinery spaces such as purifier areas and around generators.

- Nozzles are arranged in groups. Nozzles in machinery spaces are open and, following flame

detection, release is simultaneous from each nozzle in the group.

- Nozzles in accommodation spaces can be provided with a quartzoid bulb for automatic release.
- Nozzle spacing is dependent upon height of the space protected, so heads are not always interchangeable.
- Produces a very fine water mist or fog, which cools and also provides a smothering effect (steam).
- Operates at pressures of over 100 bar.
- Can be activated without risk of harming people inside the space.
- Causes minimal damage to equipment, as it uses a very small quantity of water.

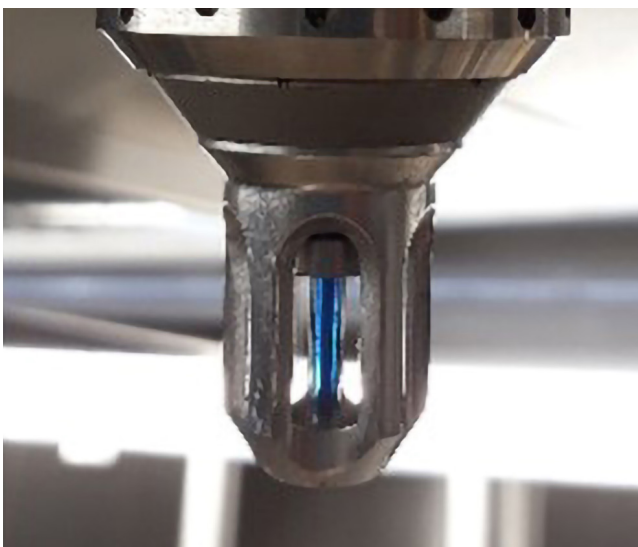

Figure 14: Water mist head - bulb intact (left) and damaged (right)

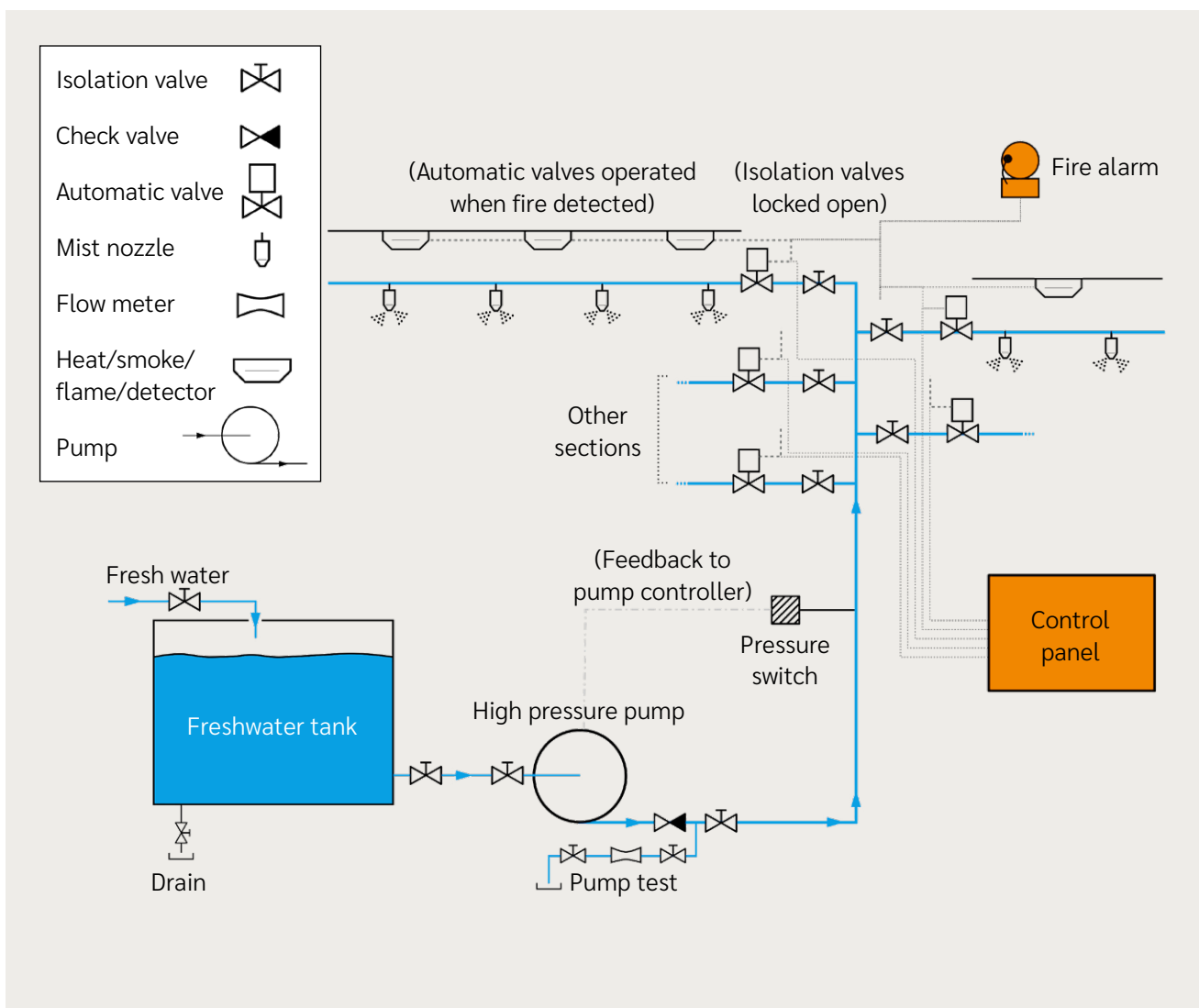

Figure 15: Water mist system

### Maintenance tips

Follow manufacturer's maintenance/operating instructions and statutory requirements set out in IMO MSC Circs 1432 and 1516 (see Appendix 3).

- Ensure that operating instructions are clear and prominently displayed.
- Ensure that valves and other system components are correctly labelled and correctly set. This is essential.
- It has been found that ships' crews intentionally disable water mist systems to prevent accidental release. Check that your system's controls are set to 'automatic' and that the system will deploy automatically. This is essential.
- Care should be taken to identify any empty or cracked glass bulbs.

## Firefighting equipment and its use continued

### High-expansion foam

Fixed firefighting equipment occasionally used in garage spaces and engine rooms. The method of extinguishment is by smothering through the manual release of large volumes of foam from fixed outlet(s).

- Provides volume coverage.
- Uses a mixture of foam concentrate, water and air.

- Smothers and provides some cooling.
- Different types of foam concentrate are available (eg protein, fluoroprotein and aqueous film), which can be used to modify the cooling and smothering properties of the foam.
- It is safer than CO<sub>2</sub> and can be used in garage spaces, where it can be released without risk to human life.

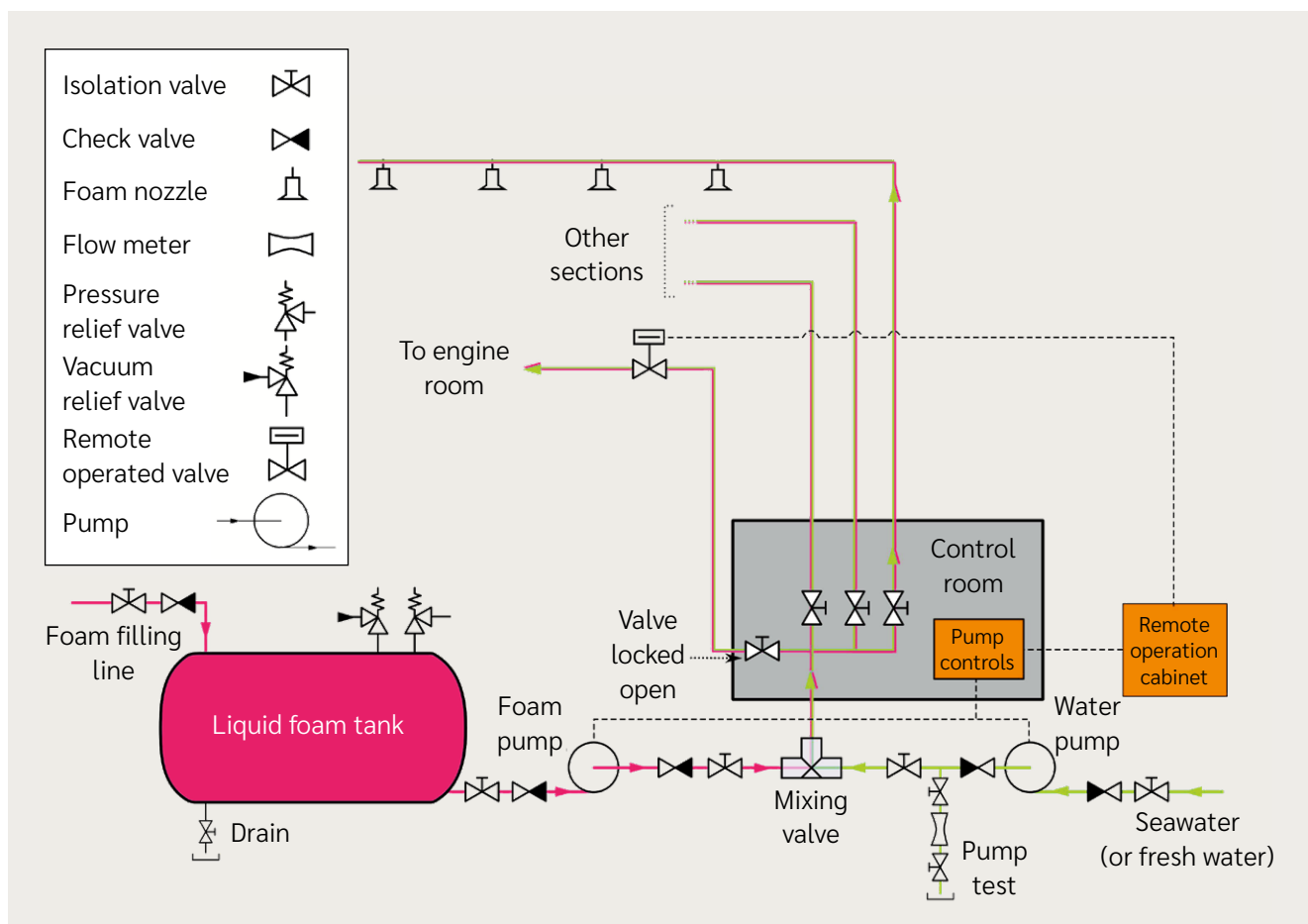

Figure 16: Water mist system

### Maintenance tips

Follow manufacturer's maintenance/operating instructions and statutory requirements set out in IMO MSC Circs 1432 and 1516 (see Appendix 3).

- Ensure that operating instructions are clear and prominently displayed.
- Ensure that valves and other system components are correctly labelled. This is essential.

- Check that controls are set for remote rather than local release. This is essential.
- Where the system permits, keep valves a few turns open. Start the foam concentrate pumps each month.
- Annually check foam concentrate (by controlled test) if the concentrate is more than three years old.

## Carbon dioxide

Fixed firefighting equipment used in garage spaces (and machinery spaces) of cargo ferries. The method of extinguishment is by displacing air and reducing the oxygen content in the compartment. This is achieved through the manual release of a large volume of CO<sub>2</sub>, through fixed outlet nozzles.

- Provides volume coverage.
- Works by reducing oxygen content in air to below the level that supports combustion.
- 45% gas concentration is required for extinguishing a fire in a garage space.

- CO<sub>2</sub> is an asphyxiant gas, ie one that can reduce the oxygen in the space's atmosphere to below the level able to support human life. CO<sub>2</sub> gas is usually stored in pressurised bottles at 56 bar or in a bulk tank at -200°C and 20 bar, in a locked room. Entry to the room should not be made until the room has been ventilated, and its atmosphere has been tested and confirmed as safe.
- Has dedicated delivery pipework.
- It is essential that compartment doors and dampers are closed and sealed before release of CO<sub>2</sub>.
- Most effective when released early, on a nascent fire.

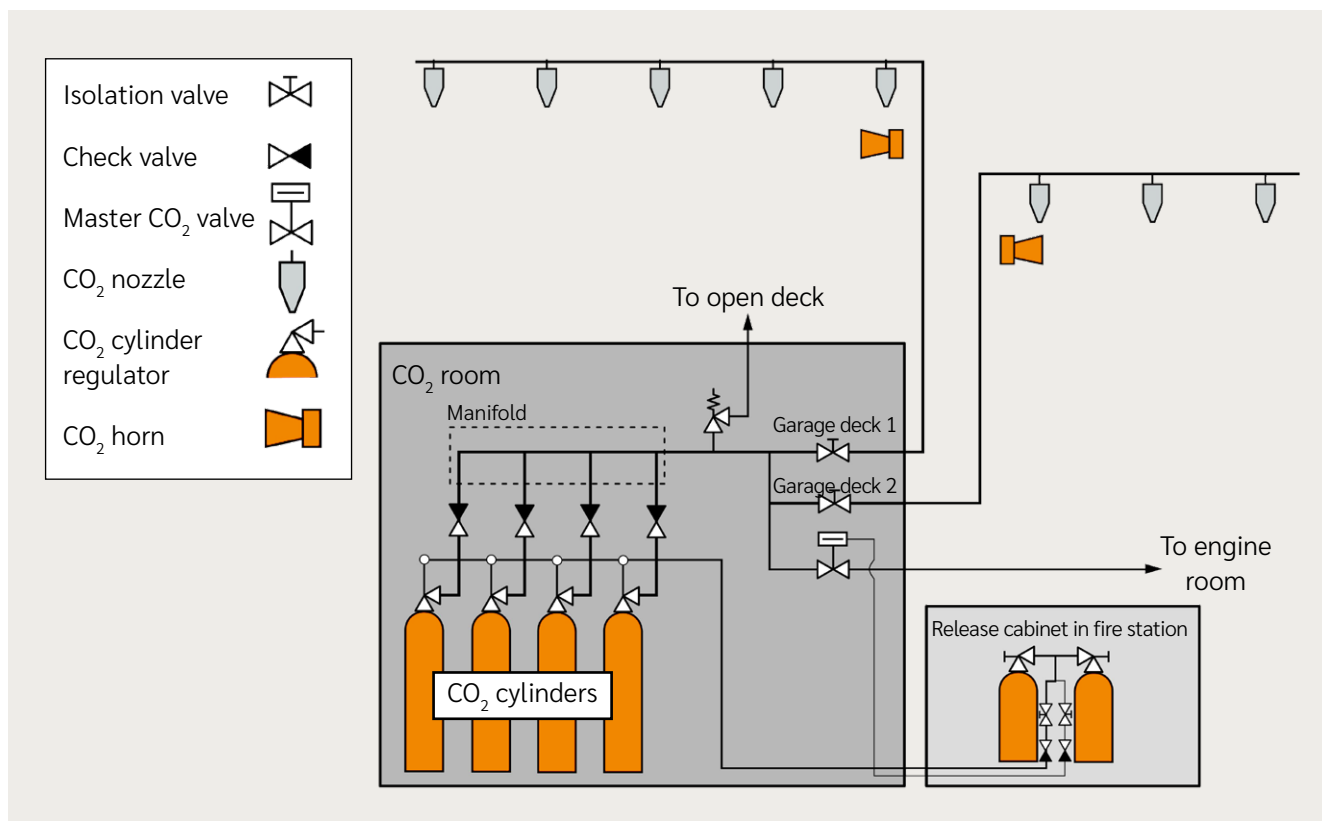

Figure 17: Carbon Dioxide system

### Maintenance tips

- Follow manufacturer's maintenance/operating instructions and statutory requirements set out in IMO MSC Circs 1318 (see Appendix 3).
- After bottles have been removed or replaced, check that the linkage and release mechanism is correct and the banks of bottles will release as required.
- Ensure, at all release stations, that there are clear instructions for operation.
- Ensure that valves and other system components are correctly labelled. This is essential.
- Ensure that CO<sub>2</sub> nozzles are not blocked or painted.
- Periodically verify CO<sub>2</sub> piping by blowing through it with compressed air.



## Firefighting equipment and its use continued

### Safety when using CO<sub>2</sub> systems





- It is essential for all personnel to be evacuated from the space, and to have been accounted for, before CO<sub>2</sub> is released. This delay to account for personnel, before activation, is both acceptable and necessary.
- The space should not be ventilated until it is confirmed that the fire has been extinguished and the space has cooled. This may involve a fire team, wearing fireman's outfits and breathing apparatuses, entering the space with fire hoses to cool any hot spot(s) that may otherwise cause reignition. Beware of reignition while ventilating.
- The space should be ventilated and the atmosphere checked with an oxygen concentration meter before

entering without wearing a breathing apparatus. It is important to carefully check for pockets of remaining CO<sub>2</sub>.

### Portable firefighting equipment

Portable fire extinguishers are the first means of attacking fire and are effective with small fires that have not taken hold.

Portable fire extinguishers look similar, but the colour of the label indicates the fire extinguishing method: red = water, blue = dry powder, cream = foam, black = CO<sub>2</sub> and yellow = wet chemical.

	Type	Extinguishing method	Used on	Not used on
	<b>Water</b>	Cooling	Dry material.	Oil, liquids or electrical fires.
	<b>Foam</b>	Smothering	Oil, combustible liquids and solid materials.	Electrical fires.
	<b>Dry powder</b>	Smothering	Dry materials, liquid fuels, flammable gases, electrical equipment (excluding high-voltage equipment).	Can be used on any fire except metal fires.
	<b>Carbon dioxide</b>	Smothering	Ideal for electrical and liquid fuel fires.	Can be used on most fires.

## 06. Emergency preparedness

It is a SOLAS requirement to keep fire protection systems, such as insulation, dampers, self-closing fire doors and fire detectors, in good working order and to have firefighting equipment available for immediate use. All crew need to know how to operate the equipment, and have confidence that the equipment is effective. This can only be achieved through regular and systematic examination, proactive planned preventative maintenance, and frequent tests and drills.

There is information on all ferries which details where fire protective/firefighting equipment is located (the Fire Control plan) and how to use the equipment (the Training Manual). The Fire Control plan will be posted on a bulkhead and the Training Manual can be found in mess rooms. These should be studied during ship familiarisation.

The Fire Control plan will show:

- the location of A-class and B-class divisions
- the location of the fire alarms
- the fixed extinguishing system and the location of the release stations
- the location of the fire pumps and hydrants
- the location of the portable firefighting equipment, hoses and extinguishers, including the fireman's outfits and breathing apparatuses
- the location of the breathing apparatus recharging facilities

- the location of the emergency stops, fire dampers and ventilator controls
- the location of the emergency generator

All crew should study the plan and memorise where the key equipment is located. The fire plan should be used during training. In an emergency, there is no time to learn about the equipment and its location.

The Training Manual will contain information on:

- general fire safety practice and precautions relating to fire hazards
- general instructions on firefighting activities and procedures
- operation of fire detection systems and their meaning
- operation of the fixed firefighting equipment
- general use of firefighting and fire safety equipment.



Figure 18: Onboard training

## Emergency preparedness continued

The Training Manual has valuable information and should be studied carefully, but it is only by using the equipment during fire drills that confidence is gained. Case studies have shown that textbook firefighting techniques, ie those taught during fire safety training ashore, are the most effective means to extinguish fire. These firefighting techniques should be practised on board during drills.

The minimum frequency of fire drills (as required by SOLAS) is monthly or when 25% of the ship's crew have changed. In practice, weekly inspection and testing is preferable for:

- self-closing fire doors
- fire alarms and detectors (section by section in rotation)
- the deluge system (section by section in rotation)
- the emergency fire pump and generator
- fireman's outfits, and breathing apparatuses and recharging facilities.

It is better for the tests to be completed by a different crew member, under the supervision of the safety officer, rather than by the same crew member. This will ensure all crew gain experience and confidence in the use of the equipment.

All crew should understand, have experience of and know how to operate:

- the portable fire extinguishers
- the fire hoses and nozzles
- the breathing apparatuses and the fireman's outfits
- the emergency fire pump and emergency generator
- the emergency stops, doors and dampers
- the deluge, high fog, water spay or CO<sub>2</sub> systems.



Figure 19: Practice drill

SOLAS states that drills 'shall, as far as practicable, be conducted as if there were an actual emergency'. As fires on ferries can occur as a result of a number of causes, training on board should attempt to replicate a variety of scenarios, such as:

- garage space fire involving the ship's electrical equipment, dry combustible material, flammable liquids, vehicles and dangerous goods. Consider access when vehicles cannot be moved because passengers have the keys and making safe other vehicles in the compartment
- accommodation fire involving galleys, cabins and storage areas
- machinery spaces involving electrical and mechanical equipment
- passenger evacuation at sea and in port when the ferry has a garage space fire.





Figure 20: Check equipment

When planning and conducting an emergency drill, consideration should be given to situations that might prevent or restrict the use of emergency equipment, such as loss of emergency power, failure of a fire door to fully close and partial failure of the fixed extinguishing system. In practice, this does occur. Analysis of performance after a drill should include human factors, such as communication, equipment usability, human physical limits, allocation of tasks and how all these can be improved. Any identified improvement should be made promptly so that it can be tested during the next drill. These should also be reported to the owners/managers.

An effective emergency drill should incorporate instructions on equipment use and firefighting before the drill and an analysis of performance after the drill. Everyone who is part of the fire response team should practise donning the fireman's outfit to check that the suit and the boots fit.

Each fire team on board is required to have a minimum of two explosion-proof or intrinsically safe two-way portable radiotelephone apparatuses for firefighter's communication.

## 07. The human element

The human element is about behaviour, about what people do instead of what they should do, about what is forgotten, misinterpreted, done correctly or incorrectly, and how to avoid mistakes.

The human element is also about design for use; for example, making sure escape signs are in the best place so they can be seen in a dark, smoke-filled compartment, and that emergency procedure(s) are easy to follow and training is effective. Consider and discuss these topics during a safety committee meeting and fire drill debrief.

Accident investigation has identified recurring themes that affect decision-making, such as experience, judgement, knowledge, appetite for risk and leadership. Importantly, these factors can alter when crew are under conditions of stress or fatigue, in an emergency, or when there is lack of understanding of a situation or knowledge of a solution. These are conditions in which mistakes can be made.

Knowledge of how people behave under conditions of stress is essential when dealing with human factors.

Think about fatigue and, if an emergency is prolonged, how to manage it. Think about situational awareness and how this is affected by stress or fear. Think about communication, and how to ensure instructions are clearly communicated and understood. Understand likely behaviour, plan for it and do not rely on luck.

The key to successful fire prevention, detection and extinguishment is the ship's crew. It is the diligence of the ship's crew in keeping a ship fire safe, checking and testing fire alarms and firefighting equipment, completing fire patrols, and observing the outbreak of fire and responding promptly that prevents ship loss through fire. The crucial importance of regular and realistic fire drills and equipment tests cannot be overemphasised. Crew need to instinctively know what to do in an emergency and how to use firefighting equipment correctly and have confidence that the equipment is fit for purpose. For this reason, fire drills and equipment tests are held.

The case studies in Appendix 1 show some potentially dangerous behaviour:

- the assumption, without verification, that a sounding fire alarm was an alarm fault rather than an indication of fire
- the reluctance to enter the garage space to investigate a fire alarm
- the failure to fully understand the release procedure for the fixed firefighting system, causing delays in its use and, in one case, the failure to activate the equipment, which had disastrous results.

Crew behaviour can also have a positive impact, as shown in the case studies:

- burning was smelt before smoke was detected
- activation of the fixed firefighting equipment brought the fire under control
- textbook firefighting techniques, taught during firefighting training and drilled on board, were followed to good effect.

The UK Maritime and Coastguard Agency (MCA) has published two very good books on the human element in shipping, which are initiatives supported by Standard Club and are recommended reading:

1. *The Human Element – a guide to human behaviour in the shipping industry* (ISBN 9780115531200)
2. *Being Human in safety-critical organisations* (ISBN 9780115535352).



Figure 21: *The Human Element – a guide to human behaviour in the shipping industry*

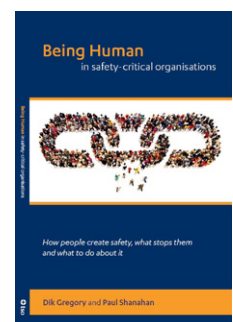

Figure 22: *Being Human in safety-critical organisations*



## 08. Accident investigation

If a fire occurs on your ship, there will be a number of interested parties who will want to know the circumstances and cause of the incident.

These include:

- flag state
- port state
- ship's classification society
- hull and machinery underwriters
- P&I insurers
- owner
- charterer
- cargo interests
- police – particularly if there are fatalities
- local authorities such as port or local fire service.

On British registered ships, the MAIB (Marine Accident Investigation Branch) will conduct the investigation on behalf of the flag state and, for incidents involving ships in British waters, they will conduct the investigation on behalf of the port state. In non-UK ports, there are similar organisations and the harbour master or the Coastguard may investigate.

Hull and machinery, and P&I insurers will investigate to establish the cause, the extent of damage and the cost of repair/replacement. P&I clubs will also look for pollution, whether a third party suffered a loss and whether third parties may have caused the incident through a negligent act, which may make them responsible for costs.

Surveyors and/or fire investigators, sometimes working in conjunction with solicitors, will look to identify:

- the area of fire origin
- the cause or potential causes
- learning outcomes that may prevent a recurrence of the incident aboard the ferry, on sister/similar ships within the company's fleet or in the industry as a whole

- learning outcomes that could result in better firefighting
- learning outcomes that could result in changes to the safety management system or to marine regulation.

The investigator will carry out an initial inspection of the fire scene, without disturbing it. At this stage, the fire investigator will be considering the extent of damage, the remaining patterns of burning, evidence of firefighting and any disturbance to the fire scene that this may have caused. The investigator will document this evidence by taking photographs and making written notes.

Thereafter, the investigator is likely to interview the crew. This is an important part of the investigation. Crew members will be able to assist by providing information about the area damaged by fire and its contents before the fire. They will be aware of routine activities and the operation of equipment within the area. Most importantly, crew will be able to provide important evidence about where the fire was first seen, how the fire behaved as it developed and spread, and the firefighting actions undertaken. The investigator will want to review closed circuit television (CCTV) video footage or Voyage Data Recorder (VDR) data, and interrogate the fire alarm systems.



Figure 23: Garage space fire  
© Central Command for Maritime Emergencies, Germany

## Accident investigation continued

The investigator will use this information to narrow down the fire's area of origin and its possible cause(s). He will take into account the most severe fire damage, which typically occurs at the area of origin, and from where the fire has spread. The investigator will take into account factors that may have affected the pattern of fire damage, such as fire loading (quantity and nature of combustible material), secondary fire, collapse of burning material and areas where the fire may have burnt for longer because the location was inaccessible during firefighting.

At this stage, the evidence gained allows the investigator to develop a working hypothesis on the fire's area of origin and its likely cause. This hypothesis will be tested during further examination of the fire scene, which will involve disturbing/searching through the remaining evidence. Searching through fire debris allows the investigator to secure evidence that was previously concealed and will help to establish more precisely the materials that first ignited and the source of ignition.

Thereafter, the investigator will be in a position to finalise his views on the area of fire origin, the first material to ignite and the likely cause. He may need to test these views by conducting laboratory analysis, literature research and/or conducting calculations. The investigator may also seek to further interview certain members of the crew to confirm points of evidence not considered during the initial interviews. Supplementary interviews are generally shorter in duration.

Crew can assist the fire investigation by ensuring that:

- a record is maintained of initial observations and the steps taken to fight the fire. This would normally be made by a designated officer at the fire command station
- log books and other documents, such as statements of facts and equipment maintenance records, are available for inspection

- there is minimal disturbance to the fire scene until after the investigation has been completed. It should be noted that some fire debris is harmful to health and advice may be needed before debris is cleared
- crew members are not discharged/signed-off until after they have been interviewed by the fire investigator.



Figure 24: Trailer fire being extinguished

The investigator will consider all aspects of the fire and firefighting to determine what can be done to prevent a similar fire from occurring and whether firefighting drills and training were adequate. They will look at:

- maintenance of fire protecting material
- maintenance of fixed and portable firefighting equipment
- testing of self-closing fire doors
- testing of fire detection and extinguishing equipment
- fire drills completed
- fire patrols completed
- actions taken from discovery of the fire to its extinguishment.

Ships' masters should seek advice from the ship owners/managers before the investigation commences to ensure they are aware of the role of different interested parties during a fire investigation.



## 09. Dos and don'ts checklist



### Do:

- Ensure that the integrity of structural fire protection is maintained and that it is not compromised during repair and/or modification.
- Make sure penetrations in compartment boundary bulkheads and decks are fire safe.
- Identify where emergency cables run and check that they are adequately protected from fire.
- Have a programme to test fire detectors and alarms so that they are all tested in rotation. Record the results in the log book(s).
- Have a programme to test fixed firefighting system(s) so that the entire system is tested every month. Record the results in the log book(s).
- Hold realistic fire drills followed by a thorough debrief in accordance with SOLAS.
- Familiarise all crew with the firefighting equipment and the potential means for fire to spread from compartments.
- Test the emergency fire pump and emergency generator during fire drills, ensuring that all crew become familiar with their operation.
- Send all crew on an advanced firefighting course.
- Keep garage spaces clean and free from combustible material, such as oil, paper and rags.
- Keep scuppers clean and free from debris. Water deluge systems can release large volumes of water.
- Stow dangerous goods safely in the properly designated area.
- Fully close fire doors and ramps, and have measures in place to ensure they remain fully closed.
- Have a continuous fire patrol giving special attention to potential fire hazards, such as operating reefer containers/equipment and vehicles with hot engines.
- Investigate every lighted 'open fire door' indication lamp.
- Investigate every fire alarm. Promptly report the discovery of fire.
- Promptly fight fire, in accordance with training.
- Be afraid of smoke – it's toxic.
- Be afraid of CO<sub>2</sub> – it's an asphyxiant.
- Ensure any equipment such as breathing apparatuses or portable radios are kept fully charged and ready for use.



### Do not:

- Cut holes in compartment boundaries or thermal insulation.
- Modify bulkhead or deck pipe and cable penetrations without correctly reinstating fire stopping.
- Paint over release nozzles in a sprinkler, deluge, CO<sub>2</sub> or high fog extinguishing system.
- Store oil in drums, wood, paper, oily rags or similar combustible material in garage spaces or in spaces without a fixed fire detection and extinguishing system.
- Wedge a fire door open or disable a door position indicator lamp.
- Allow passengers in vehicles when the ship is navigating, except on those very short voyages where passengers remain in vehicles.
- Smoke, or permit smoking, except in dedicated smoking areas.
- Disable fire detectors or fire alarm zones, without putting alternative precautions in place.
- Assume a sounding fire alarm is an alarm fault – investigate.
- Ignore smoke or unexplained heat – investigate.
- Delay firefighting – every minute is precious.
- Enter a space on fire, or one which has been on fire, on your own.
- Open a fire door or damper until the fire is completely out and the space has cooled.
- Enter a space with an extinguished fire or where CO<sub>2</sub> has been released, without wearing a breathing apparatus, until the atmosphere in the space has been tested and found to be safe.
- Switch the fire detection system off during loading/discharge – despite exhaust fumes causing false activations.

# 10. Appendix 1: Case studies

The examples that follow consider three ferries with garage space fires. They show what can go wrong and why, and what the ship's crew could have done differently. It will be seen that action taken by the ship's crew and the effectiveness of fixed firefighting equipment were crucial.

## Fire on board *Commodore Clipper*

16 June 2010



Figure 25: MAIB Investigation report

*Commodore Clipper*, a passenger car ferry, sailed from St. Helier, Jersey, at 21:45 on 16 June 2010, bound for Portsmouth. She was loaded with 77 trailers, of which 24 were refrigerated, and carried 62 passengers and 39 crew. Weather during the voyage was fair and the ship made good progress to Portsmouth.

The reefer containers were stowed above and below deck. Those stowed below deck had their reefer equipment connected to the ship's electrical power. Some containers were curtain-sided and contained pre-packaged potatoes for delivery to supermarkets.

The *Commodore Clipper* was fitted with CCTV, smoke alarms, forced draft ventilation and a drencher system in the garage space.

### Events

- 02:37: an image from a CCTV camera became hazy.
- 02:39: the breaker opened on the 400V electrical distribution system.
- 02:41: other images on CCTV cameras became grey/hazy.
- 02:42: two garage space fire alarms sounded. Although there was no history of faulty alarms, the alarms were thought to be faulty and were reset.
- 02:43: the bridge watch officer sent the lookout to the garage space to check for fire. He took a handheld radio, which did not work properly.
- 02:45: the duty engineer asked the electrical engineer to check the fire detection system for faults. By this time, fire alarms had sounded six times and had been reset each time.
- 02:46: by this time, ten different fire alarm sensors had sounded and been reset. The sounding alarm was still thought to be a fault.
- 02:48: the lookout returned to the bridge having not gone to the garage space, but he did ask two night stewards if they could smell smoke, which they could.



- 02:49: a total of 6 minutes 54 seconds after the first alarm had sounded, the fire detection system ceased to operate. By this time, a total of 16 sensors had activated 81 times, with individual alarms reset 11 times and the alarm system reset 7 times.
- 02:50: the lookout was sent to the main deck to look for smoke.
- During this period, the electrical engineer entered the garage space and found it filled with smoke. The 400V system serving the reefer containers was shut down, forced draft ventilators were switched off and dampers were closed.
- 02:54: CCTV camera showed the garage space was filled with smoke. By this time, the ship's crew were responding to the fire.
- 02:59: the lookout sent to the main deck saw flame and reported this to the bridge.
- 03:01: the general alarm was sounded.
- 03:04: the garage space drencher system was activated, which suppressed the fire.
- Emergency services arrived and Commodore Clipper finally berthed at Portsmouth at 10:55 the next morning.

From first alarm to drencher release was approximately 25 minutes.

In summary, action to extinguish the fire was delayed due to fire alarms being assumed to be false alarms. This illustrates the importance of taking all fire alarm activations seriously.

## Fire on board *Corona Seaway*, Kattegat

4 December 2013



Figure 26: *Corona Seaways*, 2013. Damaged vehicles on the main deck

The *Corona Seaway*, a freight ferry, departed Fredericia bound for Copenhagen at 21:10 on 3 December 2013. She was loaded with lorries and trailers, with 170 units stowed tightly together in her lower hold, on the main and upper weather decks, and on access ramps. On board were 19 crew and 10 passengers (drivers). She had CCTV, smoke alarms, forced draft ventilation and CO<sub>2</sub> smothering in the garage space.

### Events

- 01:30: the on-watch able seaman reported satisfactory completion of a fire patrol and all was in order.
- 02:15: a fire alarm sounded in the garage space and was observed by the bridge. Checks of the CCTV showed no evidence of smoke or fire. An able seaman was sent to investigate and looked into the garage space but did not enter. He saw neither smoke nor flame. The master arrived on the bridge and saw smoke and flame on the CCTV. The general alarm was sounded.
- 02:25: ventilation dampers were reported closed. All personnel, except for one, were mustered and accounted for.

- 02:30: the missing person was found and CO<sub>2</sub> released.
- 03:00: the upper deck drencher system was activated to provide boundary cooling.
- 03:10: it was found that only 9 tonnes of the ship's 21.3 tonnes of CO<sub>2</sub> had released. A second release of CO<sub>2</sub> was made but only a further 2 tonnes was actually released. The release of CO<sub>2</sub> brought the fire under control.
- 06:40: *Corona Seaway* was safely berthed at Helsingborg.

The reason why the CO<sub>2</sub> partially released was never identified. The ship had a low pressure system with a single storage tank.

### Fire on board *Lisco Gloria*, north-west Fehmarn

8 October 2010



Figure 27: Fire on board *Lisco Gloria*  
© Central Command for Maritime Emergencies, Germany

*Lisco Gloria*, a passenger ferry, departed Kiel at 22:00 on 8 October 2010, fully loaded with lorries and trailers. She had 32 crew and 203 passengers. Some of the trailers were reefer units. These were connected to the ship's electrical power supply system. She proceeded towards Klaipeda in fair weather with a fresh ENE'ly wind.

### Events

- 23:07: the bridge watch had changed and the on-watch able seamen completed a fire patrol, finding all in order.
- 23:58: a fire alarm sounded. At the same time, the duty able seaman smelt smoke in the garage area and the bridge watch officer checked CCTV camera images and saw smoke. The duty able seamen then reported seeing flames.
- 24:00: the master arrived on the bridge and ordered power in the garage space to be switched off.
- 00:02: only four minutes after the first fire alarm had sounded, the garage space drencher system was activated from the bridge but it failed to operate.
- 00:07: engineers tried to operate the drencher system from the engine control room but it still failed to operate.
- 00:09: the automatic sprinkler system in a garage space access activated, but shortly afterwards a water pipe under pressure burst and the sprinkler shut down.
- Around this time, the master ordered evacuation from the ship. Only 11 minutes had passed since the first fire alarm had sounded.
- 01:35: all passengers and crew had safely evacuated from *Lisco Gloria*.
- The fire was burning out of control and the ship was drifting towards Danish waters.
- On 18 October, firefighting was still being maintained with boundary cooling to reduce the high temperature, with all fires being eventually extinguished by 23 October. The ship was a total loss.

Subsequent investigation concluded that the drencher system had been in full working order but that it failed to activate because it was set to manual (local) rather than remote release. So despite the fire being detected early and the crew responding promptly, the ship was lost because the drencher system failed due to an incorrect setting. This illustrates the importance of regular checks of the firefighting systems and their settings.

# 11. Appendix 2: SOLAS chapter II-2, fire safety requirements on ship construction – fire protection, detection and extinction

Knowledge of fire safety regulations enables better understanding of fire safety in general. The following references consider the principle construction requirements for ro-ro ferries that are not carrying dangerous goods.

## SOLAS chapter II-2

- Combustible material, regulation 5 (fire growth potential) part 3, **regulation 11** (structural integrity) parts 2 and 5.
- Smoke generation (paints), **regulation 6** (smoke generation potential and toxicity) part 2.
- Fire detection systems, **regulation 7** (detection and alarm) parts 6, 7, 8 and 9, and **regulation 20** (protection of vehicle, special category and ro-ro spaces) part 4.
- Structural fire protection – requirements for main fire zones, bulkhead penetrations/openings, cargo space boundaries, protection of vehicle/special category and ro-ro spaces, **regulation 9** (containment of fire) parts 2.2, 3, 4 and 6, and **regulation 20** (protection of vehicle, special category and ro-ro spaces) part 5.
- Ventilation – requirements for air supply and precaution against flammable vapours in enclosed vehicle/special category and ro-ro spaces, **regulation 5** (fire growth potential) part 2, **regulation 8** (control of smoke spread) part 4, **regulation 9** (containment of fire) part 7 and **regulation 20** (protection of vehicle, special category and ro-ro spaces) part 3.
- Fixed extinguishing systems in cargo spaces, ro-ro/special category spaces:
  - requirements for gas (CO<sub>2</sub>) fire-extinguishing systems, **regulation 10** (firefighting) parts 4 and 7, and **regulation 20** (protection of vehicle, special category and ro-ro spaces) part 6.
  - for water-based fire-extinguishing systems, **regulation 20** (protection of vehicle, special category and ro-ro spaces) part 6 and MSC/Circ 1430, MSC/Circ 1272, Res.A.123(V) if an older system.
- Fire main and hydrants, **regulation 10** (firefighting) part 2.
- Portable fire extinguishers, **regulation 20** (protection of vehicle, special category and ro-ro spaces) part 6.2.
- Escapes, **regulation 13** (means of escape) parts 5, 6 and 7.
- Operational readiness, **regulation 14** (operational readiness and maintenance) parts 2.1, 2.2 and 3. Training and drills, **regulation 15** (instructions, on-board training and drills) parts 2 and 3, and **regulation 16** (operations) part 2.2. Plus chapter III **regulation 19** (emergency drills and training) parts 2 and 3.
- Fire Fighters Equipment, **regulation 10**, including additional Fire Team Radio Equipment.



## 12. Appendix 3: IMO Circulars

- [Guidelines for the Maintenance and Inspections of Fixed Carbon Dioxide Fire-Extinguishing Systems \(MSC.1/Circ.1318\)](#)
- [Revised Guidelines for the Maintenance and Inspection of Fire Protection Systems and Appliances \(MSC.1/CIRC.1432\)](#)
- [Amendments to the Revised Guidelines for the Maintenance and Inspection of Fire Protection Systems and Appliances \(MSC.1/ Circ.1516\)](#)
- [Revised Guidelines for the Performance and Testing Criteria, and Surveys of Foam Concentrates for Fixed Fire-Extinguishing Systems \(MSC.1/Circ.1312\)](#)
- [Interim guidelines for minimising the incidence and consequences of fire in Ro-Ro spaces and special category spaces of new and existing Ro-Ro passenger ships \(MSC.1/Circ.1615\)](#)



Figure 28: Fireman suit and breathing apparatus



Figure 29: Fire on board Lisco Gloria



Figure 30: Sources of fuel

# List of figures

Figure 1: Garage space on ship	5
Figure 2: Road trailer	6
Figure 3: Firemans suits	7
Figure 4: Fire triangle	8
Figure 5: Fuel source stored above flashpoint temperature	9
Figure 6: Potential fuel source	10
Figure 7: Compartment fire protection components	12
Figure 8: International Convention for the Safety of Life at Sea (SOLAS)	13
Figure 9: Ferry boundaries	14
Figure 10: Water spray system valves for vehicle deck	15
Figure 11: Hydrant	17
Figure 12: Water spray system	18
Figure 13: Vehicle deck drencher system	19
Figure 14: Water mist head - bulb intact (left) and damaged (right)	20
Figure 15: Water mist system	21
Figure 16: Water mist system	22
Figure 17: Carbon Dioxide system	23
Figure 18: Onboard training	25
Figure 19: Practice drill	26
Figure 20: Check equipment	27
Figure 21: The Human Element – a guide to human behaviour in the shipping industry	28
Figure 22: Being Human in safety-critical organisations	28
Figure 23: Garage space fire	29
Figure 24: Trailer fire being extinguished	30
Figure 25: MAIB Investigation report	33
Figure 26: Corona Seaways, 2013. Damaged vehicles on the main deck	34
Figure 27: Fire on board Lisco Gloria	35
Figure 28: Fireman suit and breathing apparatus	37
Figure 29: Fire on board Lisco Gloria	37
Figure 30: Sources of fuel	37



---

# Authors

## Kirk McGregor, Senior Surveyor

Captain Robert Kirk McGregor is a Master Mariner, having spent over 20 years at sea, serving as Master on feeder container ships. He has experience as a flag state surveyor and has previously worked as a master mariner expert attending container ships that have incurred deck container collapses and losses. Kirk is a senior surveyor with the club's loss prevention department.



## Paul R. Nichols, Lead Specialist

Paul R. Nichols is a Lead Specialist for Lloyd's Register of Shipping working in the Passenger Ship Support Centre. He began in the industry in 1981 with British Shipbuilders then moved to Lloyd's Register in 1988 after graduating with a B.Eng. (Hons) from University of Newcastle. Within LR he has spent time in various survey and support roles concentrating on passenger ships over the last 20 years. Paul is a Chartered Engineer, Chartered Marine Engineer, Fellow of the Royal Institute of Naval Architects and Fellow of the Institute of Marine Engineers, Science and Technology, and recently gained a Master of Science from the University of Newcastle. In recent years, his work has included supporting yards around the world in building passenger ships and he sits on various groups relating to passenger ship safety.



## Frank Anderson, Dr JH Burgoyne & Partners LLP

Frank Anderson commenced his career as a seagoing marine engineer, sailing on ro-ro/ passenger ferries, bulk carriers, passenger ships, containerships and tankers. After studying for a BSc in Marine Technology (honours in Marine Engineering) he worked as a marine surveyor in Singapore.

In 1997 he joined Burgoyne's where he has specialised in fire investigation and forensic engineering. He has investigated fires on a wide variety of ships, around the world including a number of incidents on ro-ro/ passenger ferries. He has given expert evidence in criminal courts, civil courts, arbitrations and mediations, both in the UK and overseas. He is a Chartered Engineer and Fellow of the Institute of Marine Engineering, Science and Technology.

## Burgoyne's

consulting scientists and engineers

The authors acknowledge technical contributions from colleagues and associates with particular thanks to:

- Eric Murdoch BSc, MSc, CEng, MRINA, MI MarEST
- Jane Jenkins, Lloyd's Register
- Frank Anderson, Dr JH Burgoyne & Partners LLP



Keep up to date by visiting the Knowledge Centre section on our website [standardclub.com](https://www.standardclub.com)

 @StandardPandi

 @StandardClubPandi

 The Standard P&I Club

Standard Club is comprised of the entities listed below. To identify your insurer within Standard Club please refer to your policy documents for the relevant policy year or please contact us. To best serve customers, Standard Club uses international correspondents, which may be another entity within Standard Club.

The Standard Club Ltd, incorporated in Bermuda (No. 1837), authorised and regulated by the Bermuda Monetary Authority. Managers: Standard Club Management (Bermuda) Limited, incorporated in Bermuda (No. 56069). Registered addresses: Swan Building, 2nd Floor, 26 Victoria Street, Hamilton HM 12. The Standard Club Asia Ltd, is a company incorporated in Singapore with limited liability (No. 199703224R), authorised and regulated by the Monetary Authority of Singapore. Managers: Standard Club Management (Asia) PTE. Limited, incorporated in Singapore (No. 199703244C). Registered addresses: 140 Cecil Street, #16-03/04 PIL Building, Singapore 069540. The Standard Club Asia Ltd (Hong Kong Branch), registered in Hong Kong (No. F0024636), authorised and regulated by the Hong Kong Insurance Authority (F24636). Managers: Standard Club Management (Asia) PTE. Limited (Hong Kong Branch), registered in Hong Kong (No. F0024645). Registered addresses: Suite A, 29/F 633 Kings Road, Quarry Bay, Hong Kong. The Standard Club Ireland DAC, incorporated in Ireland (No. 631911), authorised and regulated by the Central Bank of Ireland (C182196). Managers: Standard Club Management (Europe) Limited, incorporated in Ireland (No. 630355), authorised and regulated by the Central Bank of Ireland (C184973). Registered addresses: Fitzwilliam Hall, Fitzwilliam Place, Dublin 2. The Standard Club Ireland DAC (UK Branch), registered in the UK (No. BR021960), deemed authorised by the Prudential Regulation Authority, subject to regulation by the Financial Conduct Authority and limited regulation by the Prudential Regulation Authority (FRN 833593). Managers: Standard Club Management (Europe) Limited (UK Branch), registered in the UK (No. BR021929), deemed authorised and regulated by the Financial Conduct Authority (FRN 848125). Registered addresses: The Minster Building, 21 Mincing Lane, London, EC3R 7AG. Details of the Temporary Permissions Regime, which allows EEA-based firms to operate in the UK for a limited period while seeking full authorisation, are available on the Financial Conduct Authority's website. The Standard Club UK Ltd, incorporated in the UK (No. 00017864), authorised and regulated by the Prudential Regulation Authority & Financial Conduct Authority (FRN 202805). Registered address: The Minster Building, 21 Mincing Lane, London, EC3R 7AG. The Shipowners' Mutual Strike Insurance Association Europe (The Strike Club), incorporated in Luxembourg (No. B50025), authorised and regulated by the Commissariat aux Assurances. Registered address: 74, rue de Merl - BP 2217 L-1022 Luxembourg. The Strike Club UK Branch, registered in the UK (No. BR019357), deemed authorised by the Prudential Regulation Authority, subject to regulation by the Financial Conduct Authority and limited regulation by the Prudential Regulation Authority (FRN 203102). Managers: Standard Club Management (Europe) Limited (UK Branch), registered in the UK (No. BR021929), deemed authorised and regulated by the Financial Conduct Authority (FRN 848125). Registered addresses: The Minster Building, 21 Mincing Lane, London, EC3R 7AG. Details of the Temporary Permissions Regime, which allows EEA-based firms to operate in the UK for a limited period while seeking full authorisation, are available on the Financial Conduct Authority's website. The following offices provide claims services for Standard Club: Standard Club Management (Americas), Inc., incorporated in the United States (Connecticut) (No. 4050326). Registered address: 180 Maiden Lane, Suite 6A, New York NY10038; Standard Club Management (Europe) Limited (Greek Branch), Law 27/1975 Branch Office, Status Building B, Areos 2A, 166 71 Vouliagmeni, Athens, Greece; and Standard Club Management (Bermuda) Limited (Japan Branch), registered in Japan (No: 0100-03-034516). Registered address: 6th Floor Takebashi Bldg, 2-1-8, Kanda Nishiki-cho, Chiyoda-ku, Tokyo 101-0054 Japan.